

**SIMATIC**

1. About SIMAGIC	3
2. Product Highlights	
2.1 Basic Introduction	4
2.2 Basic Parameters	5
2.3 Technology Introduction	6
3. Product Details	
3.1 Throttle	7
3.2 Brake	8
3.3 Multiple adjustments	9
4. Safety Information	10
5. Warranty Description	
5.1 Standard Accessories	11
5.2 Optional Accessories	12
6. Software download	13
7. Quick guide	14-15
8. Warranty Description	16
9. Disclaimer and Notice	17

## HIGH-INTEGRATION, PROFESSIONAL RACING PEDAL



P1000



P1000i



## Dreams of Racing Fueled By Passion

Coming from modest backgrounds, but infected by the need for speed.

Although we had some talent in real life racing, the lack of funds to fuel that passion was not enough to satisfy our addiction as real life motorsports was and is still beyond the reach of many. We were however determined to find ways to improve our skills and make practice effective yet affordable.

So it started with us asking ourselves, "How do we find ways to satisfy this goal in the most immersive ways?"

In 2018, fueled by this passion and armed with advanced degrees in engineering and control systems, SIMAGIC was born.

We went about developing the kind of wheel base we wanted and needed... it had to be a direct drive for unmatched realism, yet, affordable. Easy to use and built with high quality components to last. Real carbon fiber, real metal where possible; high quality components, no compromise. After all, we were in Shenzhen, the Silicon Valley of the East, factory to the world, the talent, resources, were all here. While we were at it, we thought to ourselves, why not make it just like real race cars with a motorsports grade QR system. It's never been done before so we had to develop new ways of power delivery and data communication to do this. The result is the much loved and flatteringly imitated QR system and 2.4G wireless communications system that have become so familiar in sim today.

Aug 2018, The M10 was introduced to the world and it catapulted SIMAGIC into the consciousness of sim racers all over. SIMAGIC became the subject of memes...

It has been 3 years since and what followed after were GT Wheel Series, FX wheel series, a Servo Base series, Pedals, Sequential Shifter, handbrake and more, the SIMAGIC ecosystem is only just the beginning.

3 years is neither short nor long. Short for the amount of innovation and products that we have developed, long enough to have proven that we are here for the long haul and our products have stood the test of time and our commitment to all who have believed in us.

One thing remains unchanged, we started with motorsports as a passion and we will continue to drive this point in every product we develop and every innovation we come up with. Everything we do is benchmarked and tested by real drivers who believe in the art of sim as a tool for real life driving. We will continue to commit ourselves to being the choice of real drivers and those who strive to be one. This will always be the one thing that sets us apart from everyone else. The game just got seriously fun...so KEEP RACING!

## 2.1 Basic Introduction

- \* High-integration, professional race pedal
- \* Jointly developed with race engineers
- \* Featuring a brand new optimized design
- \* Modular integrated design, quick replacement of Rubber Pads
- \* Loadcell sensor and Hall angle sensor can be switched easily
- \* Precision Redefined: Unleashing the Power of CNC technology
- \* Can be adapted to suit the driving styles of different players
- \* SIMAGIC's newly patented linear motor simulate the same forces experienced in real automobiles, offering realistic and unmistakable feedback.
- \* The optional P-HYS hydraulic brake system is available for purchase providing a more accurate reproduction of the damping and rebound of genuine car brakes



## 2.2 Basic Parameters

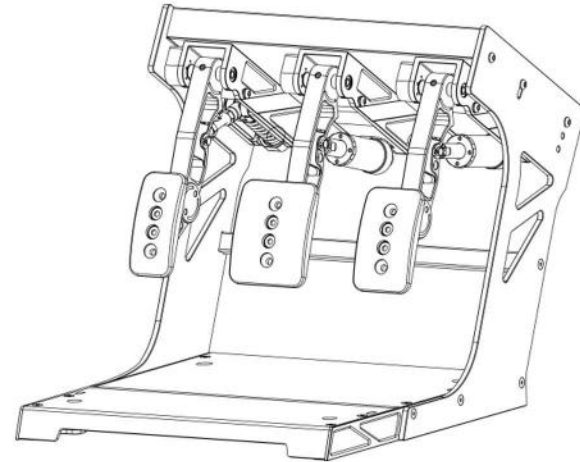
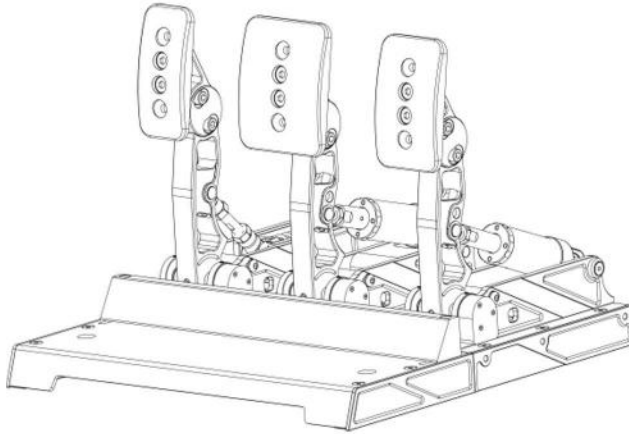

P1000 Dimensions (Length x Width x Height) : 334.8mmx336mmx267mm

P1000i Dimensions (Length x Width x Height) : 348mmx489.8mm x368.5mm

P1000 Net Weight : 5.65KG

P1000i Net Weight : 7.60KG

## 2.3 Technology Introduction



Dual sensors switched freely



Hydraulic conduction



CNC manufacturing



Concave clutch design



Height adjustable



Adjustable stroke

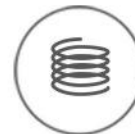

Optional spring



Adjustable strength

## 3.1 SENSOR



Loadcell sensor and Hall angle sensor can be switched freely

A) For civilian cars with long travel distance Hall angle sensors are more accurate

B) For racing cars with short travel distance Loadcell sensor are more accurate



## 3.2 RUBBER PADS



Modular integrated design, quick replacement of Rubber Pads supports free combination. It can be combined up to 27648 different formulas, which is enough to match all preferences.



90 P



80 P



80 R



70 R

(P— Polyurethane R— Rubber)

## 3.3 MULTIPLE ADJUSTMENTS



THE PEDAL SPACING IS ADJUSTABLE



PEDAL HEIGHT CAN BE ADJUSTABLE



THROTTLE STRENGTH IS ADJUSTABLE LIGHT AND HEAVY



PITCH ANGLE IS ADJUSTABLE



ADJUSTABLE PEDAL STROKE



QUICK CLUTCH ADJUSTMENT

## Safe Operation

- \* **Power-on instruction: before turning on the power, make sure that the power cord is connected to the wheelbase. Only unplug the power cord when the wheelbase is switched off.**
- \* It is strictly forbidden to expose the device and its power supply to rain or humidity in order to avoid short circuit and electric shock that may cause device malfunction and fire.
- \* Desired temperature of operation is 15 ° C-35 ° C.
- \* The recommended operation time of the wheel with continuous force feedback activity is 1 hour. Excessive use may cause health risks. We suggest taking a 5-minute break every 20 minutes. Do not drive for more than 2 hours a day.
- \* Although this product has force feedback configuration, children under 13 years old must be under parental supervision to complete the configuration. Parental guidance is required to monitor children's use of the device.
- \* This product contains small pieces and is not suitable for children under 13 years old to use alone.
- \* When you use it for the first time, please adjust the force feedback from minimum to where you are accustomed to.
- \* In the game, if the feedback force previously set is beyond your control, please stop the game immediately and adjust the force feedback parameters in time.
- \* The wheelbase contains components that cannot be repaired by the user. Opening the casing is forbidden and may cause harm to people or property.
- \* Do not open the casing of the device, as it will void the warranty.

## Electrical Safety

- \* Use only the power supply and power cord that came with your wheelbase, which is important to protect your safety, rights, and interests.
- \* Do not use a non-standard power supply and power cord.
- \* To ensure safety, replacements may only be issued from an authorized repair center.
- \* Do not use non-standard power sources, even if the voltage and frequency appear acceptable.
- \* To avoid product damage, use only AC power with a standard wall socket.
- \* Do not expose your wheelbase to sources of heat.
- \* Unplug the power cord of your wheelbase when unused for long periods of time.
- \* If the wheelbase is found to have any malfunctions, stop using it immediately and contact SIMAGIC Official or authorized center for help.
- \* Please subscribe to SIMAGIC official website and social platforms for the update of product information.

 **\* This product is only limited to simulation driving related activities. Please distinguish simulation games from reality and drive safely!**

## 5.1 Standard Accessories



Mounting screw pack



Clutch pedal springs



Rubber pads



USB data cable



Heel-stop



Warranty card

## 5.2 Optional Accessories



P-HPR(Haptic Pedals Reactor)



P-HYS(Hydraulic System)



P-APS(Accessories Power Supply)



P-SRB(Sim Ray - Bar)



P-SRH(Sim Ray - Heel Stop)



Optional rubber pad kit

OPTIONAL ACCESSORIES\*REQUIRES P1000 ACCESSORIES POWER SUPPLY (SOLD SEPARATELY)

Scan the QR code to download the Driver Software



Click on the link below to download the Driver Software:

<https://www.simagic.com/download>

## 1.0 List of accessories

Fully-Threaded Bolt (M8-12)*4	Fully-Threaded Bolt (M8-16)*4
Pan Head Screw (M8-12)*8	Fully-Threaded Bolt (M6-12)*6
Roll in T-nut with Ball Spring (M6-40)*6	Flange Nut (M8)*4
Flat Head Socket Cap Screw (M5-10)*6	Red Spring*1
Lubricating Grease*1	Yellow Spring*1
5mm Allen Key with Rubber Handle*1	Cable Clip*4
Allen Key*5 (2.5mm/3mm/4mm/5mm/6mm)	12*13mm Open spanner*1
<i>(P1000i additional accessories)</i>	
Pan Head Screw(M5-10)*6	Flat Head Socket Cap Screw(M5-10)*8

## 2.0 Overall installation instructions

### 2.1 P1000 base assembly

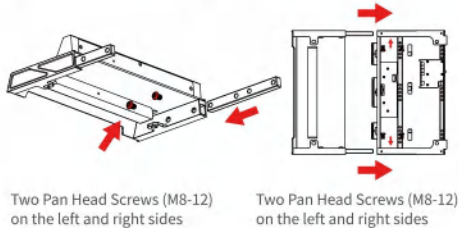

### 2.1 P1000i inverted platform Installation

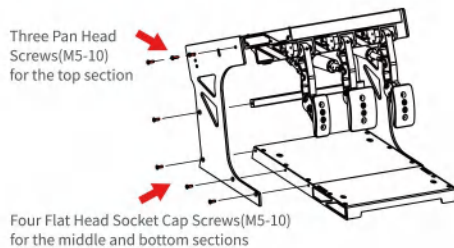

### 2.2 Sim Rig installation

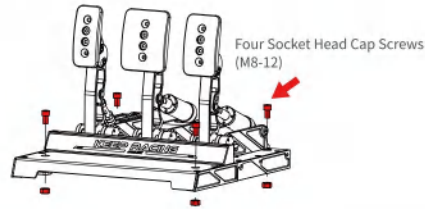

### 2.3 Installation for Customized Frames

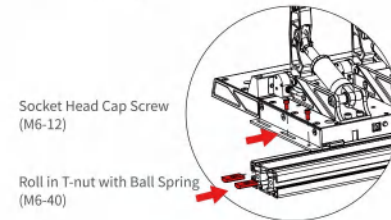
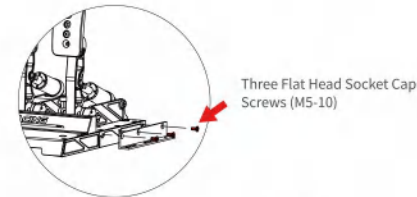

### 2.4 Connection (USB and Independent Power Supply)

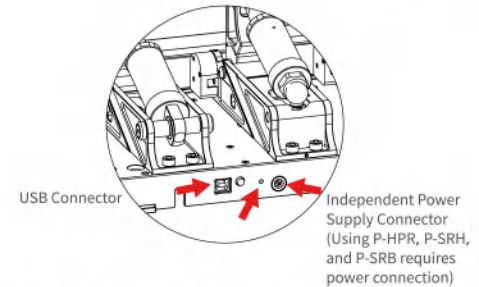

### 2.5 CAN-Bus and USB switching

Push the button to switch the pedal connection mode

Switch to CAN-Bus mode when the pedal is connected to the **SIMAGIC WheelBase** (In CAN-Bus mode, the indicator is **blue**)

Switch to USB mode when the pedal is connected to a **PC** (In USB mode, the indicator is **green**)

## 3.0 Adjustments

### 3.1 Adjust the pedal face angle

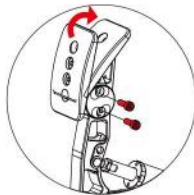

Loosen the two screws on the side of the pedal  
Adjust the angle upwards or downwards

### 3.2 Pedal Plate Height Adjustment

Loosen the two screws on the front of the pedal  
The pedal plate can be moved up or down

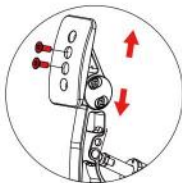

### 3.3 Heel Stop Adjustment

Loosen the top two screws of the heel stop  
The heel stop can be moved forward or backward



### 3.4 Adjust the Pedal Position (Left or Right)

Loosen the four mounting screws  
The pedal can be adjusted left and right

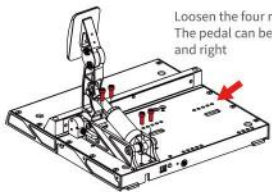

### 3.5 Travel adjustment (Bottom Limit Screws)

Loosen the two side screws  
then slide the limiter  
forward or backward to fine  
tune the pedal travel

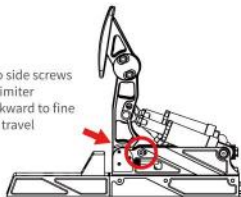

### 3.6 Throttle Strength Adjustment



The Throttle resistance can be adjusted by switching the installation hole

### 3.7 Clutch adjustment and spring replacement

Yellow Spring→Soft  
Blue Spring→Medium hardness  
Red Spring→Hard



3.7.1 Rotate the rear adjustable screw to fine tune the spring force

3.7.2 Replace the Clutch spring

- ① Loosen the rear adjustable screw
- ② Push the tail end forward and upwards to remove and replace the spring

### 3.8 Replacing the Brake Rubbers

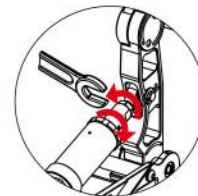

1. Loosen the jam nut on the back of the Brake, then spin the silver rod clockwise until completely loosened

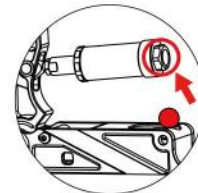

2. Lift up the brake cylinder and unscrew the red cap to access the rubbers  
(When disassembling and assembling, note that the groove at the arrow is facing down)



Hardness: black→gray→blue→red  
(From soft to hard)

**Note:**

It is recommended to use no more than 8 Rubber Pads in the cylinder

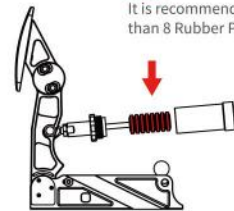



The SIMAGIC team, guided by the responsibility of reassuring customers, devote ourselves to the manufacturing industry with a humble spirit of the service industry. We strive to build a sim-racing ecosystem with the best user experience.

To protect the rights and interests of consumers, SIMAGIC provides you a 12-month service.

To request a warranty service order, please contact SIMAGIC service team or an authorized SIMAGIC service provider.

To obtain warranty service, you must fill out the warranty card and deliver it with the product to the SIMAGIC After-sale Service Center.

\* SIMAGIC's 12-month warranty policy allows you to replace or repair your purchased SIMAGIC items counting from the date of receipt of shipment. If you cannot provide the receipt, the warranty period counts from the manufacture date.

The warranty does not cover any Damage caused by abuse, misuse, or modifications; or Damage caused by any improper operation performed by anyone who is not a SIMAGIC representative.

For more information on after-sale or warranty service, please check out our Terms and Conditions at [SIMAGIC.COM](https://www.simagic.com) or contact us @simagicofficial via social media platforms like YouTube and Facebook.

- \* This product has strong force feedback strength and contains small parts. Children are forbidden to use the device without parental guidance.
  - \* Please turn off the button and power supply to prevent accidents.
  - \* Anyone trying to use your device for the first time must be instructed and monitored by you the owner.
  - \* Loose clothing and easily tangled objects such as hair, cables, and skirts should be kept away from the device.
  - \* For more information regarding software update, please refer to the SIMAGIC website and follow us on Twitter, Facebook, and Instagram @Simagicofficial.
  - \* Users MUST wait for 1 hour before driving a car if they had been using the device.
  - \* This instruction manual is for demonstration purposes only, not for marketing purposes. It is a general instruction of a single product (including the relevant series products). Please refer to the actual item for your purchase.
  - \* The product images and contents shown above are for demonstration purposes only. The actual products may vary slightly in terms of the external design (including but not limited to appearance, colors, and sizes) and the content display (including but not limited to backgrounds, UIs, and pictures). Please check the actual products for reference.
  - \* The test data above are all sampled from the SIMAGIC test laboratory and may not reflect the actual performance due to conditions of use and environmental factors. Please refer to the actual using experience for performance evaluation.
  - \* The above contents, such as descriptions and images, are subject to changes. SIMAGIC may adjust relevant contents to provide more accurate product information, specification, and feature description at any time based on the actual products in terms of performance, specification, index, and other information. Sometimes, the product supply may fluctuate due to unforeseen problems happening in the process of batching or delivery. In that case, SIMAGIC may change relevant descriptions and images as needed without notification. Please refer to official channels for the latest information.
- \* Note: Documents like product manuals are written based on SIMAGIC products as supplements. Please download the relevant documents at approved channels for the security of users' legitimate interest.

Thank you for reading and have a good time



Official website: [www.simagic.com](http://www.simagic.com)  
International media platform: SIMAGIC official

This manual is updated without notice.

The latest manual and any SIMAGIC related information can be found on the official website .  
If you have any questions and/or suggestions about this instruction manual or SIMAGIC products,  
please contact us through the information channel.