

| | |
|---------------------------------|-----------|
| 1. About SIMAGIC | 3 |
| 2. Product Introduction | |
| 2.1 Overview | 4-5 |
| 2.2 Steering Wheel Layout | 6 |
| 2.3 Basic Parameter | 7 |
| 2.4 Technical Introduction | 8 |
| 3. Basic Settings | |
| 3.1 Download the software | 9 |
| 4. Safety Suggestion | 10 |
| 5. Packing Brief | 11 |
| 6. Quick Release | 12 |
| 8. Warranty Description | 13 |
| 9. Disclaimer and Notice | 14 |

GT Cup Steering Wheel

Welcome to the Direct Drive Revolution.





Founded in July 2018 in Shenzhen, a young city of dreams, SIMAGIC Tech Co., Ltd has become a leading force nationwide in the sim-racing field, who provides high-end simulation devices to customers and overall solutions to the industry.

"Full dedication to promoting sim-racing culture" is SIMAGIC's cardinal principle and spirit. "Leading the trend of Sim-racing technology and innovation" is the goal of our branding. With that belief in mind, we devote ourselves to filling the vacancy in China's sim-racing industry. Our innovation and optimization of products never stop. WE are in the vanguard of sim-racing technology. It's our mission to build smart and advanced sim-racing equipment for car-racing game lovers, reproduce authentic racing experiences for players, and provide a brand new sim-driving application for the driving industry.

Jinquan Li, founder and CEO of SIMAGIC, graduated from Shenzhen University with a master's degree in Control Theory and Engineering. His commitment lies deep in the study of control system and driving mechanism. With his team, plus equipped with passion and professionalism, they have been through a 3-year journey of sweat and effort preparing for the best. After the rollout of its first commercial Direct Driving Wheelbase in August 2018, SIMAGIC made its name nationwide. Three years were rather short but long enough for SIMAGIC's innovation to go forward. M10 Base, GT Wheel Series, α Servo Base, Pedals, Sequential Shifter, and more, the SIMAGIC family is booming. Now, we have become the only sim-racing company that integrates R&D, production, and marketing, and revolutionized driving simulation systems with overall upgrades in customization and development.

In the future, SIMAGIC's spirit of "be guided by technology, be led by intelligence" will go even further. We'll actively pursue product development through science and technology, explore the infinity of the best user experience, and develop a new sim-racing culture based on "China's intelligent manufacturing."

2.1 Overview

- * 325mm Formula Steering Wheel. 5 mm high-quality carbon fiber plate makes the wheel durable, rigid, and light-weight.
- * Light weight wheel body: 1850 g. The reduced rotational mass gives a greater feeling of road details.
- * Two types of Grip Materials: Leather or Alcantara (Optional).
- * 2 thumb encoders, 1 RGB ABS Rotary Encoder, 1 RGB TC Rotary Encoder.
- * 2nd gen button designs that minimize travel but maximize the crisp feeling.
- * Patented HALL paddle module designed for crisp shifting, precise activation, and durability.
- * Patented button cap stickers, easy to apply.
- * Next generation driver software: SimPro Manager.
- * One multi-function RGB light, aka SIMAGIC S-ray. Configure a RAY that suits you best.
- * 8 customizable RGB buttons, 2 rotary encoder buttons, Two 7-way Multi-position Rotary Switch.



GTC Single Pick

GTC-C Double Clutch



Leather



Alcantara



Leather



Alcantara

2.2 Steering Wheel Layout

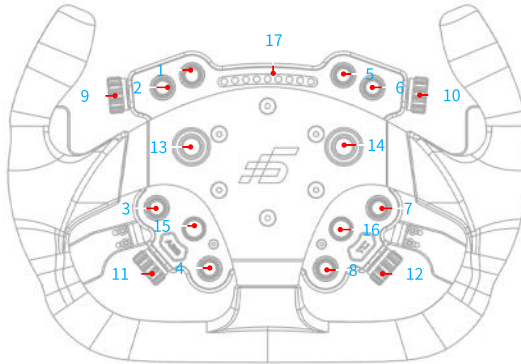

Front image

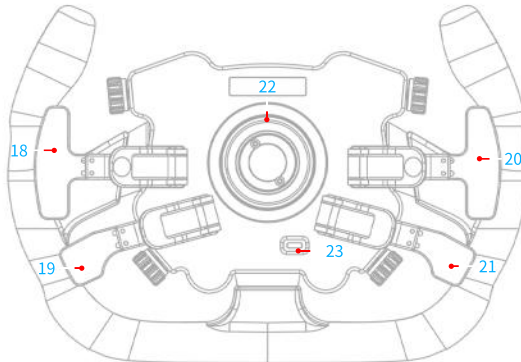

Back image

1-8: Customized RGB lights for in-game settings

9-12: Thumb Rotary Encoders

13-14: Rotary Encoders

15-16: 7-way Multi-position Rotary Switch

17: SIMAGIC S-ray Multi-function RGB light

18: Paddle modules A

19: Paddle modules B

20: Paddle modules C

21: Paddle modules D

22: SIMAGIC Quick Release

23: USB

2.3 Specifications

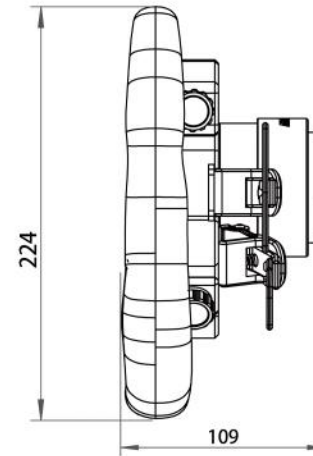
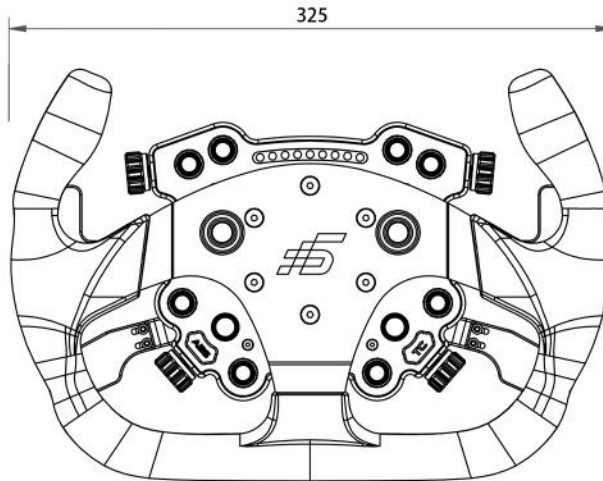

HoleSpacingLayout(mm)

FX Formula Steering Wheel

Width : 109mm

















Height : 224mm

Length : 325mm

FX Weight : 1.4kg

FX-C Weight : 1.5kg

2.4 Technical Introduction

| | | | |
|---|---|---|---|
|  | 325mm Formula Steering Wheel. Light weight wheel body: 1850 g. |  | One multi-function RGB light, aka SIMAGIC S-ray. |
|  | Patented button cap stickers (128x). |  | 50mm SIMAGIC Quick Release. |
|  | 8 customizable RGB buttons, 2nd gen button designs that minimize travel but maximize the crisp feeling. |  | Patented HALL paddle module. |
|  | 5 mm high-quality carbon fiber plate . |  | 2 rotary encoder buttons. |
|  | Next generation driver software: SimPro Manager. |  | Two 7-way multi-position switch. |
|  | TwotypesofGripMaterials:LeatherorAlcantara(Optional). |  | 2 thumb encoders,1 RGB ABS Rotary Encoder, 1 RGB TC Rotary Encoder |
|  | Paddle shifters can be adjusted horizontally and vertically. |  | (Optional) Dual Clutch paddle system. |
|  | Patented soft glow LED lights. Every RGB light is adjustable, clear and non-intrusive. |  | Patented next gen button design minimizes travel while maximizing tactile feedback. |

3.3 Light Regulation

Scan the QR code to download the diver software



Click on the link below to download the diver software:

<https://www.simagic.com/download>

Safe Operation

- * **Power-on instruction: before turning on the power, make sure that the power cord is connected to the wheelbase. Only unplug the power cord when the wheelbase is switched off.**
- * It is strictly forbidden to expose the device and its power supply to rain or humidity in order to avoid short circuit and electric shock that may cause device malfunction and fire.
- * Desired temperature of operation is 15°C-35°C.
- * The recommended operation time of the wheel with continuous force feedback activity is 1 hour. Excessive use may cause health risks. We suggest taking a 5-minute break every 20 minutes. Do not drive for more than 2 hours a day.
- * Although this product has force feedback configuration, children under 13 years old must be under parental supervision to complete the configuration. Parental guidance is required to monitor children's use of the device.
- * This product contains small pieces and is not suitable for children under 13 years old to use alone.
- * When you use it for the first time, please adjust the force feedback from minimum to a level you are accustomed to.
- * In the game, if the Force Feedback previously set is beyond your control, please stop the game immediately and adjust the force feedback parameters.
- * The wheelbase contains components that cannot be repaired by the user. Opening the casing is forbidden and may cause harm to people or property.
- * Do not open the casing of the device, as it will void the warranty.

Electrical Safety

- * Use only the power supply and power cord that came with your wheelbase, which is important to protect your safety, rights, and interests.
- * Do not use a non-standard power supply and power cord.
- * To ensure safety, replacements may only be issued from an authorized repair center.
- * Do not use non-standard power sources, even if the voltage and frequency appear acceptable.
- * To avoid product damage, use only AC power with a standard wall socket.
- * Do not expose your wheelbase to sources of heat.
- * Unplug the power cord of your wheelbase when unused for long periods of time.
- * If the wheelbase is found to have any malfunctions, stop using it immediately and contact SIMAGIC Official or authorized center for help.
- * Please subscribe to SIMAGIC official website and social platforms for any update regarding product information.

 * **This product is only limited to simulation driving related activities. Please distinguish simulation games from reality and drive safely!**

5.1 Package Brief



USB data cable



Allen Key
1.27mm/2mm/3mm



Tweezer



SIMAGIC Stickers for DIY



Warranty Card



① Retract the red shell of the quick release toward the steering wheel (retract the shell when removing the quick release)



② After aligning the holes of the base, insert the steering wheel into the base



③ If the quick release cannot be locked, it may be because the holes are not aligned. Rotate the steering wheel or remove it and insert it again.

Note: SIMAGIC's customized quick release adopts a high-precision design with six beads on the top and four beads on the bottom. The steel ball holes must be aligned with the base to access the base.

A One-year Limited Warranty is offered on SIMAGIC products. SIMAGIC guarantees that this Product is free of defects in materials or workmanship under normal use during the Limited Warranty Period.

This Limited Warranty Period commences from the date of purchase. The buyer must retain the warranty card and receipt, which will be required by your Purchase Site or SIMAGIC Authorized Distributors, as a condition of receiving warranty service. The buyer is guaranteed a warranty repair service within the Limited Warranty Period.

During the Limited Warranty Period, SIMAGIC will, at its sole discretion, repair or replace any defective parts or components of the Product.

Obtaining Warranty Support

SIMAGIC products are sold through a distribution network. The network is built upon careful selection of reliable distributors to provide valuable services to the customer, including providing after-sales service for hardware issues, helping optimize gaming experiences, and connecting with SIMAGIC HQ.

1. To request a Warranty service, please contact the Authorized Distributor you purchased from.
2. When purchasing from a second-hand dealer, make sure to obtain the warranty card and receipt from the dealer.

Any product that is NOT originally sold by a SIMAGIC Authorized Distributor will automatically be excluded from the Limited Warranty Service.

Many unauthorized resellers do not fully disclose the risks associated with buying from them.

Please be cautious when making your purchase.

Check the Official Distributor list for reference: <https://www.simagic.com/#/PageMainEn/PageShoppingEn>

For more information on after-sale or warranty service, please check out our Terms and Conditions at SIMAGIC.COM or contact us @simagicofficial via social media platforms like instagram and Facebook.

- * This product has strong force feedback strength and contains small parts. Children are forbidden to use the device without parental guidance.
 - * Please turn off the button and power supply to prevent accidents.
 - * Anyone trying to use your device for the first time must be instructed and monitored by you the owner.
 - * Loose clothing and easily tangled objects such as hair, cables, and skirts should be kept away from the device.
 - * Your SIMAGIC DDW is ready to use after being unboxed. We make sure the firmware is updated to the latest version when it leaves the factory. For more information regarding software update, please refer to the SIMAGIC website and follow us on Twitter, Facebook, and Instagram @Simagicofficial.
 - * Users MUST wait for 1 hour before driving a car if they had been using the device.
 - * This instruction manual is for demonstration purposes only, not for marketing purposes. It is a general instruction of a single product (including the relevant series products). Please refer to the actual item for your purchase.
 - * The product images and contents shown above are for demonstration purposes only. The actual products may vary slightly in terms of the external design (including but not limited to appearance, colors, and sizes) and the content display (including but not limited to backgrounds, UIs, and pictures). Please check the actual products for reference.
 - * The test data above are all sampled from the SIMAGIC test laboratory and may not reflect the actual performance due to conditions of use and environmental factors. Please refer to the actual user experience for performance evaluation.
 - * The above contents, such as descriptions and images, are subject to changes. SIMAGIC may adjust relevant contents to provide more accurate product information, specification, and feature description at any time based on the actual products in terms of performance, specification, index, and other information. Sometimes, the product supply may fluctuate due to unforeseen problems happening in the process of batching or delivery. In that case, SIMAGIC may change relevant descriptions and images as needed without notification. Please refer to official channels for the latest information.
- * **Note: Documents like product manuals are written based on SIMAGIC products as supplements. Please download the relevant documents at approved channels for the security of users' legitimate interest.**



Official website: www.simagic.com
International media platform: SIMAGIC official

This manual is updated without notice.

The latest manual and any SIMAGIC related information can be found on the official website .
If you have any questions and/or suggestions about this instruction manual or SIMAGIC products,
please contact us through the information channel.